

DESCRIPTION

The ZTWD thermostat controls the heating and cooling system and the distribution of heating and cooling to the upstairs and downstairs zones to provide a uniformly comfortable home. The thermostat is installed in the downstairs living zone, a temperature sensor is installed in the upstairs bedroom zone and two modulating dampers are installed in the ducts controlling airflow to the upstairs and downstairs zones..

During heating and cooling calls, the ZTWD thermostat checks the temperature at the upstairs sensor and the temperature at the thermostat every 2 minutes and if there is a 2° or more difference, the ZTWD automatically adjusts the modulating dampers to direct more heating or cooling to the zone that needs it for a uniformly comfortable home.



Patent US 10,520,212 B1

FEATURES

SYSTEM MODES

Off, Heat or Cool

FAN MODES

Auto or On (Continuous)

THERMOSTAT MODES

Hold or Schedule

PROGRAMS PER DAY

Morning, Daytime, Evening and Night.

PROGRAM FORMAT

Weekdays and Weekend – 5/2.

TEMPERATURE OVERRIDE

Temperature is held for 3 hours when adjusted in Schedule mode.

AIRFLOW COMFORT SELECTION

Automatic Uniform Comfort

Thermostat monitors the upstairs and downstairs temperatures and automatically adjusts the distribution of heating and cooling to the upstairs and downstairs to keep the spaces within 2° of each other. Factory default.

Upstairs Comfort Focus

More heating or cooling is directed upstairs and less to the unoccupied downstairs, and the upstairs temperature sensor is used to control heating and cooling calls.

Downstairs Comfort Focus

More heating or cooling is directed downstairs and less to the unoccupied upstairs, and the thermostat is used to control heating and cooling calls.

NIGHTTIME COMFORT CONTROL

Automatically directs 30% more heating or cooling to the upstairs sleeping zone and 30% less to the unoccupied downstairs living zone. Upstairs sensor is used to control heating and cooling calls. Factory set to Off.

AIRFLOW LIMITS

40% to 160%.

AIRFLOW CONTROL

Factory set to On. When set to Off, thermostat operates as a typical thermostat controlling equipment only.

COMPATIBLE EQUIPMENT

Gas/Electric 2H/1C or 1H/2C or Conventional Heat Pump with single stage compressor with single stage auxiliary heating.

COMPATIBLE TEMPERATURE SENSOR

(1) TS510W sensor or (2) TS520W sensors.

COMPATIBLE MODULATING DAMPERS

Model R80CT - Round damper or Model RT80CT - Rectangular damper.

POWER

Operates on 24VAC from the HVAC equipment using the R and C terminals. Battery back up to maintain time.

WARRANTY

5-year warranty, limited to the repair or replacement of the product due to defective material or workmanship.

THERMOSTAT OVERVIEW

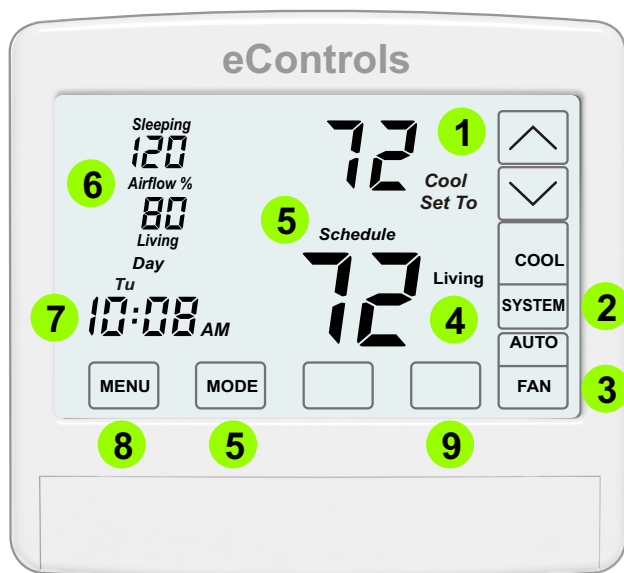

- 1 Displays the heating or cooling setpoint temperature.
- 2 SYSTEM Mode - OFF, HEAT, COOL
- 3 FAN Mode - AUTO or ON.
- 4 Displays the room temperature for the Living or Sleeping zones. Press to display the temperature.
- 5 Displays the Thermostat Mode - Hold or Schedule.
- 6 Displays the amount of heating or cooling being directed to the downstairs living zone and upstairs sleeping zone. Press to select Uniform Comfort, Upstairs Comfort Focus or Downstairs Comfort Focus.
- 7 Displays the time and day of the week.
- 8 MENU - Used to access homeowner options.
- 9 INSTALLER Options - Press and hold for about 7 seconds to access installer options.

THINGS TO KNOW

Factory Settings

Most installations require no changes to factory settings.

Airflow Comfort Selection

Accessed by touching where Airflow % is displayed.

Airflow Adjustments

If there is a large differential between the upstairs and downstairs temperatures, the thermostat will make a larger initial adjustment to airflow. Thereafter, the airflow will dynamically adjust in 2% increments every 2 minutes.

INSTALLATION

CAUTIONS

- Before installing the ZTWD system, turn off all power to the HVAC system.
- Read and follow all instructions carefully.
- Read entire manual before installing products.
- Follow all local electrical codes during installation. All wiring must conform to local and national electrical codes.
- Use cautions when mounting components to surfaces that may have concealed wiring beneath the surface.
- When servicing products or accessing products, turn off all power to these items.

INSTALLATION STEPS

1. Rough-In Wiring
2. Install and Wire Dampers
3. Install Thermostat Subbase
4. Wire Subbase
5. Install and Wire Sensor(s)
6. Install Thermostat and Set Options
7. Commission Installation
7. Install Batteries and Set the Time

1. ROUGH IN WIRING

Use 18 or 20 gage thermostat cable.

Rough-In HVAC Equipment Wiring

Install a 6-conductor thermostat cable from the thermostat location to the HVAC equipment. The thermostat location should be on a downstairs wall in the living space, about 5 feet off the floor, where it will best detect the temperature for the downstairs space.

Rough-In Damper Wiring

Install a 6-conductor cable or two 3-conductor thermostat cables from the thermostat location to the damper locations. When two 3-conductor cables are used be sure to mark the cable with the damper name—Upstairs Damper or Downstairs Damper.

Rough-In Temperature Sensor Wiring

Install a 2-conductor thermostat cable from the thermostat location to the sensor location. The temperature sensor location is on an upstairs wall, about 5 feet off the floor, in a space that will best detect the temperature for the upstairs space. The sensor fits in a standard single gang switch box or can be mounted directly to the wall.

INSTALLATION

2. INSTALL and WIRE DAMPERS

Install Dampers

Install an R80CT or RT80CT damper in the trunk supplying air to the upstairs zone. Install a second R80CT or RT80CT damper in the trunk supplying air to the downstairs zone. Install so crimped end is in the direction of airflow. Each damper uses 2.4VA of power.

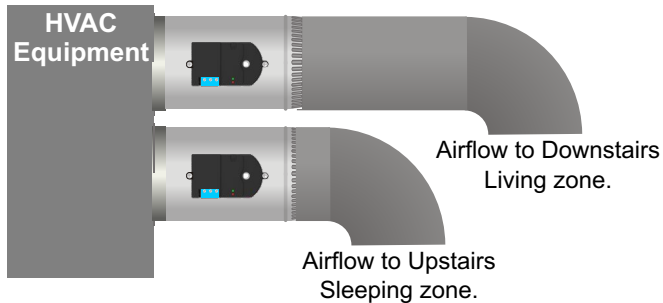

! Ensure that damper installation does not cause obstruction to the damper blade.

Wire Dampers

Connect the thermostat cable(s) installed during rough-in to the actuator on the upstairs sleeping space damper and the actuator on the downstairs living space damper.

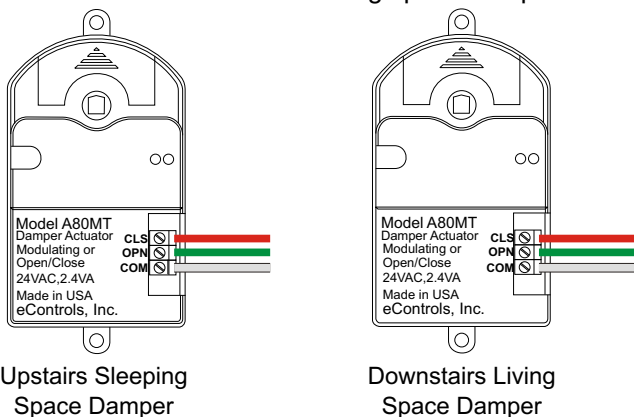

3. INSTALL THERMOSTAT SUBBASE

Remove the subbase from the thermostat by placing a slotted screwdriver in the slots as shown and rotating to remove subbase from the thermostat housing.

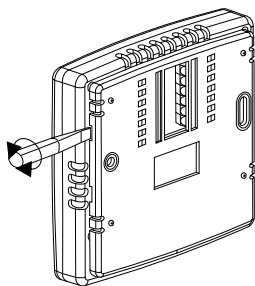

Feed the wires through the opening. Attach the subbase using the screws and wall anchors supplied.

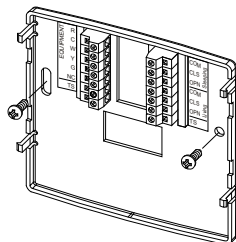

4. WIRE SUBBASE

Wire Dampers to Subbase

At the subbase connect the upstairs damper wires to the three terminals on the subbase marked SLEEPING. Make sure COM is going to COM, OPN to OPN and CLS to CLS.

Connect the downstairs damper wires to the three terminals on the subbase marked LIVING. Make sure COM is going to COM, OPN to OPN and CLS to CLS.

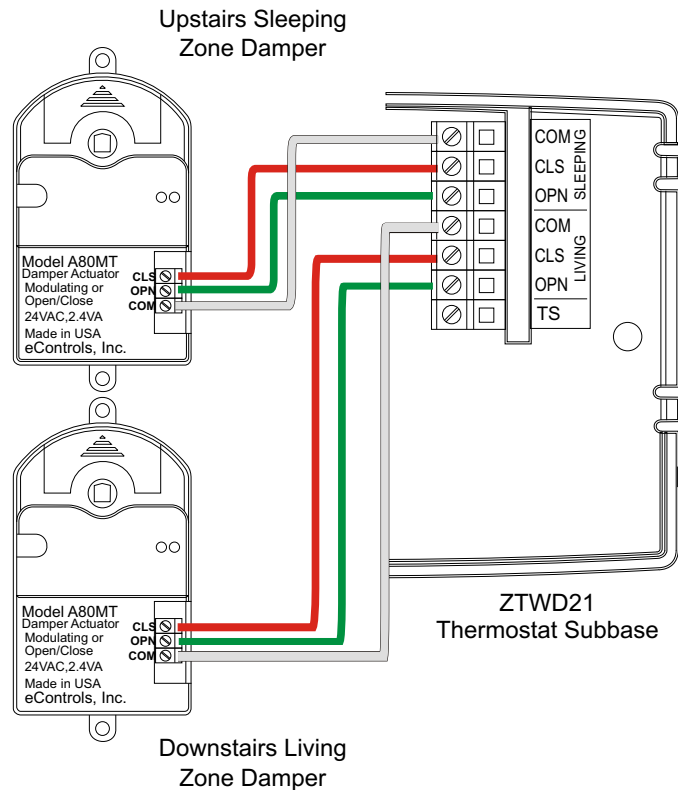

Wire Equipment

At the subbase connect the equipment wires to the equipment terminals on the subbase. Connect the equipment wires to the terminals at the equipment.

Note: Wire colors may vary.

Gas/Electric 1H/1C

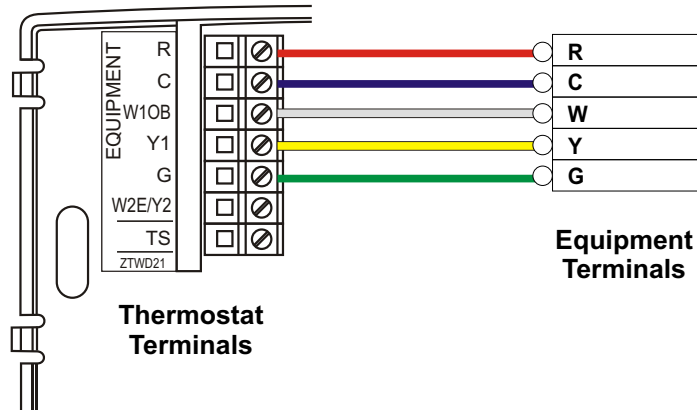

INSTALLATION

Gas/Electric 2H/1C

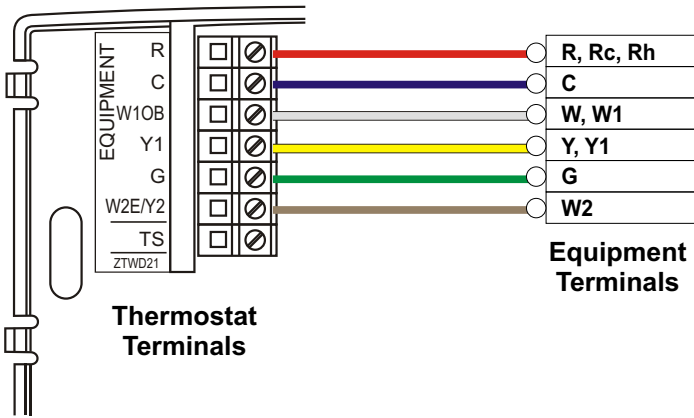

Gas/Electric 1H/2C

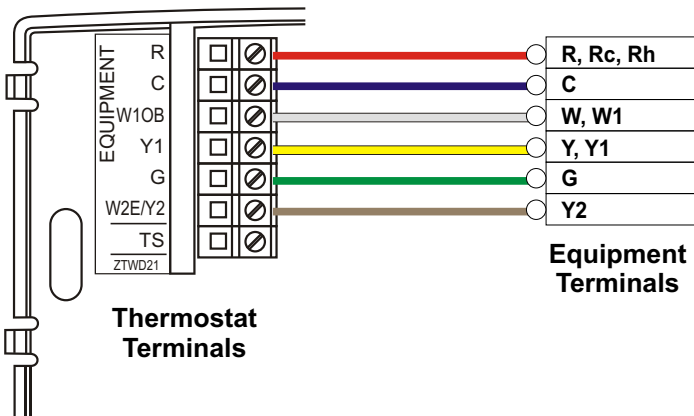

Heat Pump 1 Compressor / 1 Heat

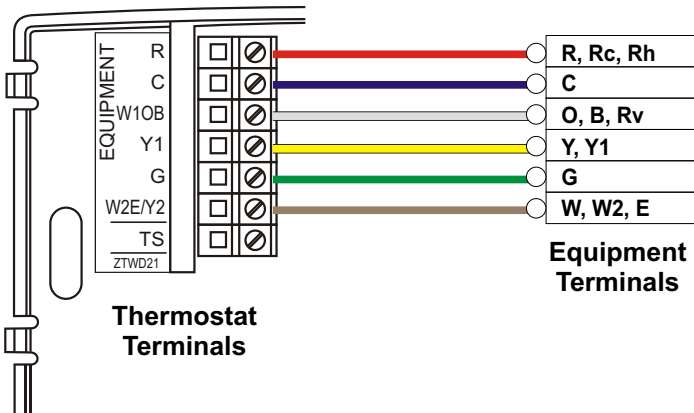

4. WIRE SUBBASE (Cont.)

Wire Sensor

At the subbase connect the sensor wires to the two terminals on the subbase marked TS.

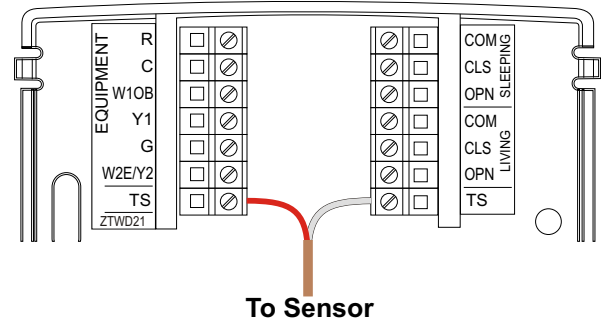

5. INSTALL and WIRE SENSOR(S)

Single Sensor Installation

Make sure you are using model TS510W. Connect the sensor wires to the sensor by placing the wires between the brass washers and the printed circuit board. Hand tighten the screws. Install the sensor in a single gang box or directly to the wall using the hardware provided.

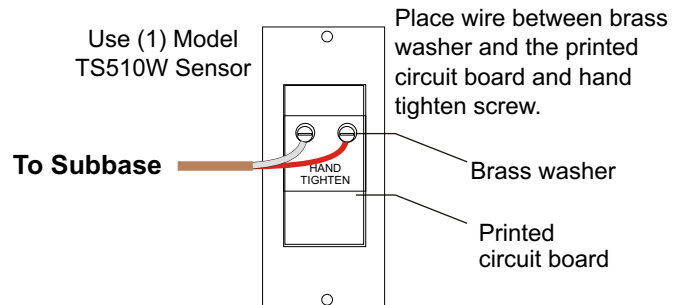

Dual Sensor Installation

For a dual sensor installation make sure you are using two model TS520W sensors. Connect the sensor wires from both the subbase and the second sensor to the first sensor by placing the wires between the brass washers and the printed circuit board. Hand tighten the screws. Connect the sensor wires to the second sensor. Install the sensors in a single gang box or directly to the wall using the hardware provided.

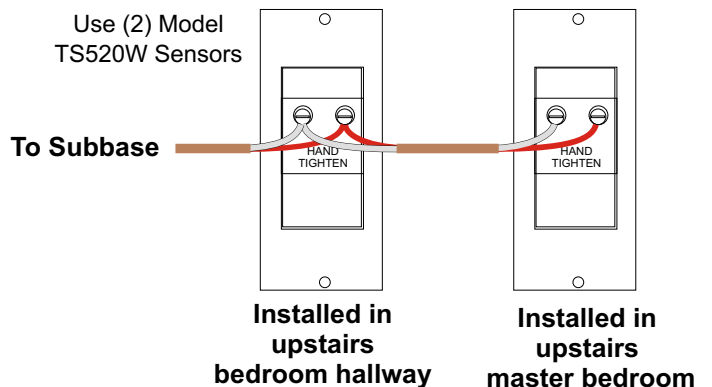

INSTALLATION

6. INSTALL THERMOSTAT and SET OPTIONS

Power the equipment. Place the thermostat on the subbase. The display should light up. If the display is blank or you have error messages, see troubleshooting.

Most installations using gas/electric equipment with 1H/1C require no change to factory settings.

OPTIONS						
Option	Applicable Equipment	Display	Factory Setting	Description	Range	Set To
01	GE or HP	GE	GE	Equipment Type	GE or HP	
02	HP Only	rEV	O	Reversing Valve	O or b	
03	GE or HP	CPr	GE 1 HP 1	Compressor Stages	GE 1 or 2 (See Note 1) HP 1	
04	GE Only	HtG	1	Heating Stages	1 or 2 (See Note 2)	
05	GE Only	FAn	GA	Fan Operation	GA or EL	
06	HP Only	AUH	1	Auxiliary Heating Stages	0 or 1	
07	HP Only	AHd	30	Auxiliary Heating Delay	10 to 180 minutes	
08	GE or HP	COt	2	Compressor Minimum Off Time	0 to 9 minutes	
09	GE or HP	HOt	1	Heating Minimum Off Time	0 to 9 minutes	
10	GE or HP	r n t	1	Minimum Run Time	0 to 9 minutes	
11	GE or HP	C A L	na	Calibrate Downstairs Living Zone Temp	+/- 5F	
12	GE or HP	C A L	na	Calibrate Upstairs Sleeping Zone Temp	+/- 5F	
13	GE or HP	AFC	On	Airflow Control	On or Off	
14	GE or HP	Fr	No	Factory Restore	No (Enter) Yes (UP key then Enter)	

Note 1: For GE equipment, the Compressor Stages can be set to 2 only if Heating Stages is set to 1 in Option 4.

Note 2: For GE equipment, the Heating Stages can be set to 2 only if Compressor Stages is set to 1 in Option 3.

ACCESSING INSTALLER OPTIONS

To access the Installer Options, press and hold the blank key to the left of the Fan key.

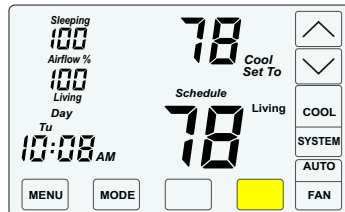

01 Select Equipment Type

Select the equipment type.

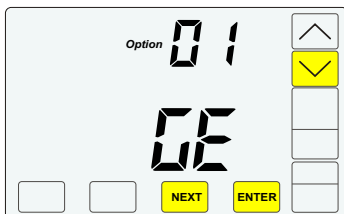

Default is gas/electric equipment (GE). Use ∇ key to select (GE)

Press **NEXT** or **ENTER**

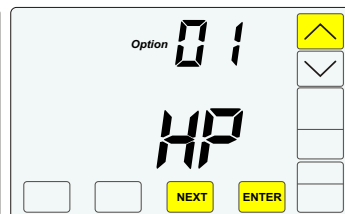

Use \triangle key to select (HP) for heat pump equipment.

02 Reversing Valve (HP Equipment Only)

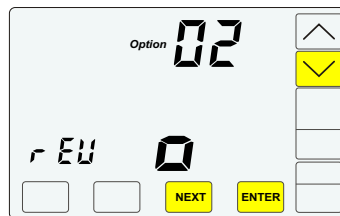

Default is (O) type. Use ∇ key to select (O) type

Press **NEXT** or **ENTER**

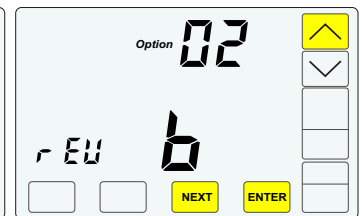

Use \triangle key to select (B) type.

03 Compressor Stages

Use the \triangle or ∇ key to select the number of compressor stages.

Press **NEXT** or **ENTER**

Note 1: For GE equipment, the Compressor Stages can be set to 2 only if Heating Stages is set to 1 in Option 4.

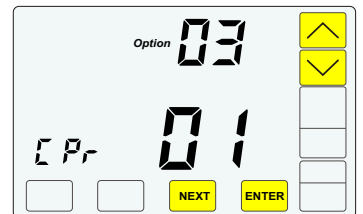

04 Heating Stages (GE Equipment Only)

Use the \triangle or ∇ key to select the number of heating stages.

Press **NEXT** or **ENTER**

Note 2: For GE equipment, the Heating Stages can be set to 2 only if Compressor Stages is set to 1 in Option 3.

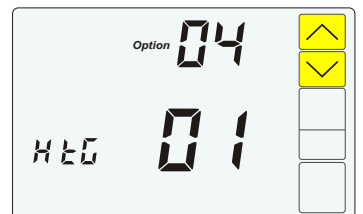

INSTALLATION

05 Fan Operation (GE Equipment Only)

Set fan operation to gas or electric. Default is gas (GA).

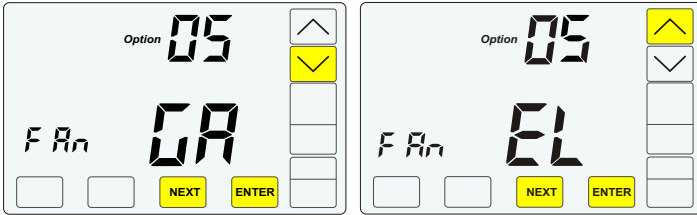

Default is gas (GA). ∇ key is used to select (GA) for gas operation where the equipment plenum sensor activates the indoor fan in heating calls.

Use \triangle key to select (EL) for electric operation where the thermostat activates the indoor fan (G terminal) during heating calls.

Press **NEXT** or **ENTER**

06 Auxiliary Heating Stages (HP Equipment Only)

Use the \triangle or ∇ key to select the number auxiliary heating stages.

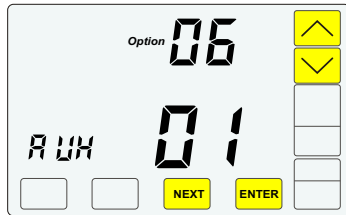

Press **NEXT** or **ENTER**

07 Auxiliary Heating Delay (HP Equipment Only)

Use the \triangle or ∇ key to select the number of minutes to delay activating auxiliary heating.

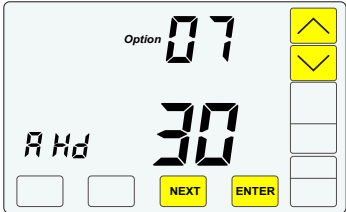

Press **NEXT** or **ENTER**

08 Compressor Minimum Off Time

Use the \triangle or ∇ key to set the minimum off time (minutes) before restarting the compressor.

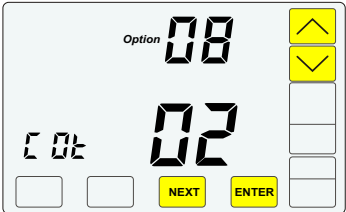

Press **NEXT** or **ENTER**

09 Heating Minimum Off Time

Use the \triangle or ∇ key to set the minimum off time (minutes) before restarting a gas furnace or electric strip heater.

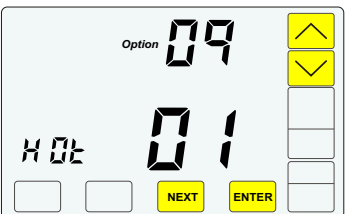

Press **NEXT** or **ENTER**

10 Minimum Run Time

Use the \triangle or ∇ key to set the minimum run time (minutes) before turning the system off.

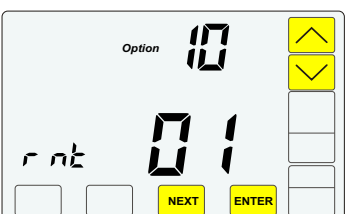

Press **NEXT** or **ENTER**

11 Calibrate Downstairs Zone Temperature

This option calibrates the downstairs living temperature to the temperature that the homeowner feels is correct.

Use \triangle or ∇ key to change the Living area temperature to the temperature that the user feels is correct.

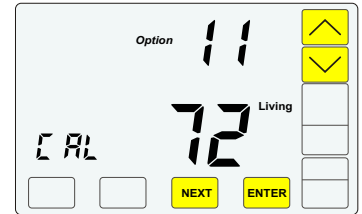

Press **NEXT** or **ENTER**

12 Calibrate Upstairs Zone Temperature

This option calibrates the upstairs sleeping temperature to the temperature that the homeowner feels is correct.

Use \triangle or ∇ key to change the Sleeping area temperature to the temperature that the user feels is correct.

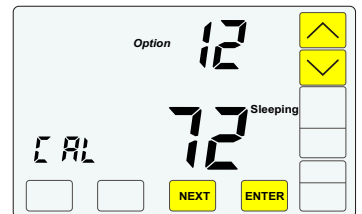

Press **NEXT** or **ENTER**

13 Airflow Control, On or Off

This option turns the automatic airflow control on or off. If off, the dampers fully open, nighttime airflow options are disabled and airflow is no longer displayed on the thermostat.

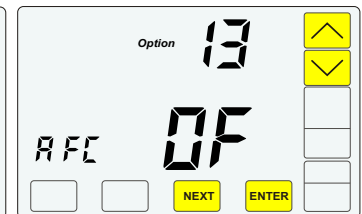
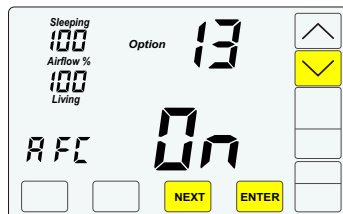

Press ∇ to select AFC OFF

Airflow % is no longer displayed.

to disable airflow control.

Press **NEXT** or **ENTER**

14 Factory Restore

WARNING! Factory Restore resets ALL settings.

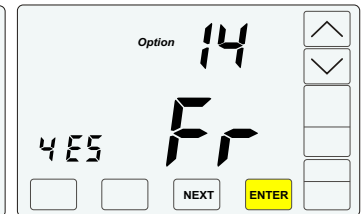
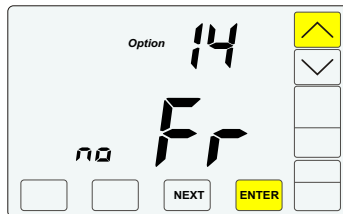

To exit this option, press **ENTER**. To restore factory settings, press the \triangle to display FR YES then press **ENTER**.

INSTALLATION

7. COMMISSION INSTALLATION

Commissioning Using the Thermostat

TEST FAN OPERATION

Press **FAN** to display ON to turn the fan on. Check that the fan is activated. To return to auto fan operation, press **FAN** to display AUTO.

TEST HEATING

Press **SYSTEM** to display HEAT and increase the Set To temperature to activate a Heating call. Wait about 2 minutes for the blower to turn on. Check that the equipment is supplying warm air.

TEST COOLING

Press **SYSTEM** to display COOL and decrease the Set To temperature to activate a Cooling call. Wait about 2 minutes. Check that the equipment is supplying cold air.

TEST DISTRIBUTION OF AIRFLOW

With cooling activated, press where Airflow % is displayed. Press **NEXT** until only the Living Airflow % is displayed. Press **▽** until 100% is displayed then press **ENTER**. Feel or measure the airflow to the Sleeping and Living zones. You should feel about equal airflow in both the upstairs and downstairs zones. If not, see Airflow Troubleshooting.

DOWNSTAIRS LIVING ZONE AIRFLOW

Press where Airflow % is displayed. The Living Airflow % will display. Press **△** to increase airflow to 160% then press **ENTER**. Check that the airflow to the Downstairs zone has increased and the airflow to the Upstairs zone has decreased. If not, see Airflow Troubleshooting.

UPSTAIRS SLEEPING ZONE AIRFLOW

Press where Airflow % is displayed. Press **NEXT** until only Sleeping Airflow % is displayed. Press **△** to increase airflow to 160% then press **ENTER**. Check that the airflow to the Upstairs zone has increased and the airflow to the downstairs zone has decreased. If not, see Airflow Troubleshooting.

RETURN AIRFLOW TO FACTORY SETTINGS

After completing successful airflow tests, return the airflow settings to the factory defaults of 130% and return to Automatic Uniform Comfort.

Press where Airflow % is displayed. Press **NEXT** until the Sleeping Airflow % is displayed. Press **▽** to decrease airflow to 130%. Press **NEXT** to display the Living Airflow %. Press **▽** to decrease airflow to 130%. Press **NEXT** to display Uniform Comfort (Sleeping and Living Airflow %) then press **ENTER**.

7. COMMISSION INSTALLATION (Cont.)

TEST TEMPERATURE IN SLEEPING SPACE

Display the Upstairs Sleeping Zone temperature on the thermostat by pressing the **Living** temperature. Ensure that the temperature reading is reasonable. An unusually high or low temperature reading could indicate that a wrong sensor was installed or that the wiring is not connected. The sensor model number should be TS510W for a single sensor installation and TS520W for a dual sensor installation. Measure the resistance at the TS terminals on the thermostat subbase. You should measure 10K OHMs @ 77°F. If the room temperature is lower than 77°, the resistance is higher. If the room temperature is higher than 77°, the resistance is lower.

! AIRFLOW TROUBLESHOOTING

If you do not receive the correct airflow results, check the damper wiring. See the chart below for damper position and LED indicator according to airflow. You should never see a red LED.

Airflow Displayed	Upstairs Sleeping Space Damper	Downstairs Living Space Damper
100% Upstairs 100% Downstairs	Open Green LED	Open Green LED
More Airflow Directed Upstairs	Open Green LED	Partially Closed No LED
More Airflow Directed Downstairs	Partially Closed No LED	Open Green LED

INSTALLATION

8. INSTALL BATTERIES and SET THE TIME

The batteries should be installed and the time set just prior to walk through.

Install the Batteries

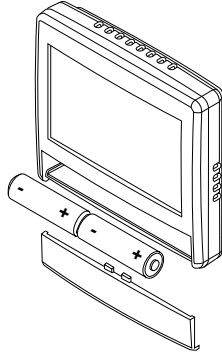

The equipment provides power to the thermostat for thermostat operation. The batteries maintain time if there is a power outage. Slide the battery cover downward and install the two AA batteries as shown. Change the batteries about every two years.





Set the Time

Press the area where the time is displayed.



Hour

Press  to advance the HOUR or  to set back the HOUR. Make sure that AM/PM reflects correctly. Press **NEXT** .

Minute

Press  to advance the MINUTE or  to set back the MINUTE. Press **NEXT** .

Day

Press  to advance the DAY or  set back the DAY. Press **ENTER** .

TROUBLESHOOTING

ERROR MESSAGES

BLANK LCD

When the equipment is powered up and there are no batteries in the thermostat, a blank LCD indicates that there is no power to the thermostat. Check the wiring from the thermostat to the equipment for errors and make sure the pins on the back of the thermostat are intact. If you put batteries in the thermostat and the LCD is still blank, there may be an issue with the thermostat. Please contact us.

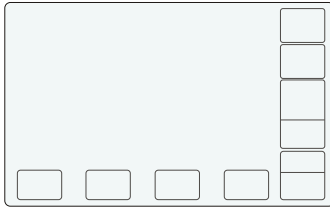

NO POWER MESSAGE

nP is displayed when batteries are installed but the thermostat is not receiving power from the equipment. If the message is displayed when the equipment is powered, check the wiring at the thermostat and the equipment for errors and make sure the pins on the back of the thermostat are intact. Measure voltage between the R and C terminals on the subbase using a volt meter set to AC. You should measure 24VAC to 28VAC.

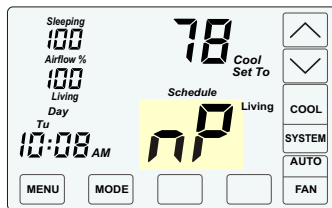

SENSOR ERROR MESSAGE

nS is displayed when there is an error with the temperature sensor. Check for open wires or shortages.

When wired correctly, a volt meter set to at least 20K

Ohms measuring between the two TS terminals on the subbase, will read approximately 10K at 77°. It will read higher when the temperature is lower, and will read lower when the temperature is higher.

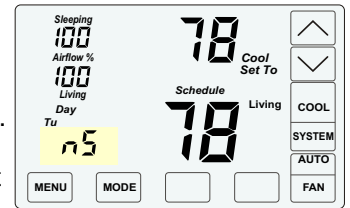

When the nS message is displayed, the thermostat will continue to control the system and automatically opens both dampers and disables airflow control until the sensor error is corrected.

Warranty

This thermostat is warranted to be free of defects due to workmanship or materials under normal use and service for a period of 5 years from date of installation and not longer than 6 years from manufacturing date code.



26072 Merit Circle #110 / Laguna Hills, CA 92653
949-916-0945 Fax 949-458-8502 www.eControlsUSA.com